

# MEISTERSTÜCK CLASSIC DUO OVAL

- Classic design with oval contour and conical outer lines
- Ovale, symmetrische Liegefläche bildet eine harmonische Erscheinung im Bad
- Installation note: The free space under the bathtuballows installation without screed recesses

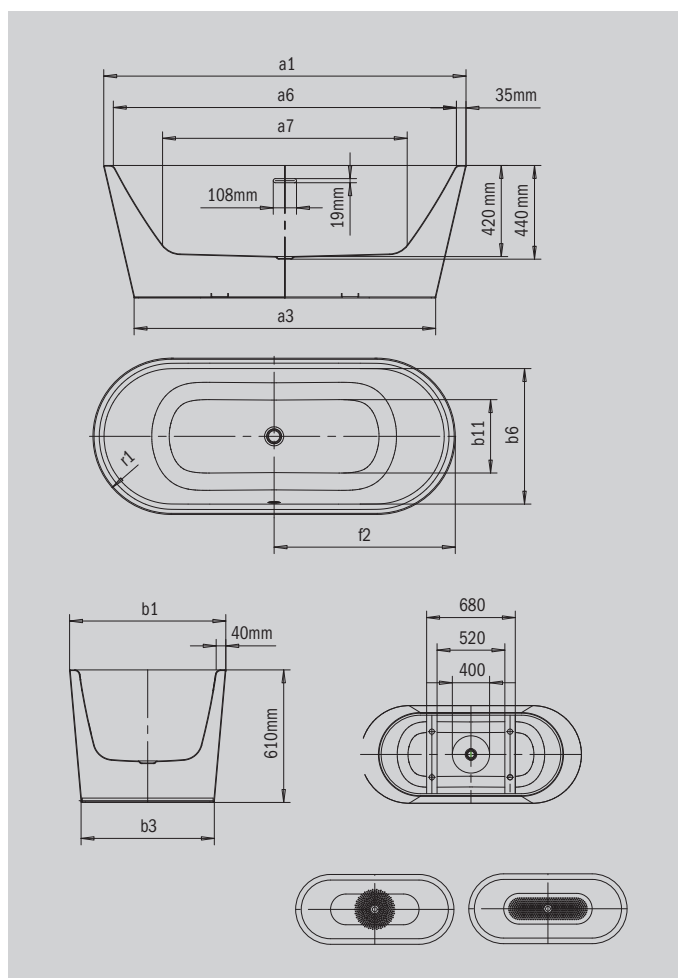

Similar illustration



Model		1022-4034
External length [mm]	$a_1$	1750 mm
External length (bottom) [mm]	$a_3$	1468 mm
Internal length (top) [mm]	$a_6$	1680 mm
Internal length (bottom) [mm]	$a_7$	1230 mm
External width [mm]	$b_1$	760 mm
External width (bottom) [mm]	$b_3$	653 mm
Internal width (top) [mm]	$b_6$	680 mm
Internal width (bottom) [mm]	$b_{11}$	510 mm
Depth inside [mm]	$c_1$	420 mm
Depth incl. waste hole [mm]	$c_2$	440 mm
Height of bath [mm]	$c_{19}$	610 mm
Width of rim (foot end; long side) [mm]	$e_1; e_2$	35; 40 mm
Distance top edge to centre of overflow hole [mm]	$f_1$	70 mm
Distance bath edge to centre of waste hole [mm]	$f_2$	875 mm
Distance centre of waste hole to centre of overflow hole [mm]	$f_7$	330 mm
Diameter of waste hole [mm]	$f_9$	Ø 52 mm
Width overflow hole [mm]	$f_{15}$	108 mm
Height overflow hole [mm]	$f_{16}$	19 mm
External radius [mm]	$r_1$	380 mm
Water volume [l]		158 l
Net weight [kg]		110 kg
Diameter of anti-slip [mm]		Ø 435 mm
Full anti-slip		900 x 300 mm